

AFT25evo

Instruction Manual



Florian **Schambeck**
Luftsporttechnik



Florian **Schambeck** Luftsporttechnik Meisterbetrieb
Stadelbachstr. 28 82380 Peissenberg
Tel.: 08803/4899064 Fax: 08803/489664

schambeck@klaptriebwerk.de

www.klaptriebwerk.de



Contents

- I. Warnings and safety instructions
- II. Terms of guarantee
- III. Checklist
- IV. Installation instruction
- V. Doors assembly
- VI. Electrical wiring schematic
- VII. Propeller adjusting
- VIII. Operation description
- IX. Remote control and SLS control
- X. Motor controller
- XI. Maintenance
- XII. Technical data
- XIII. Attachment: Sketches
- XIV. Flight logbook

I. Warnings and safety instructions

Congratulation for your purchase of this new generation self launch system (SLS) for gliders. The operation of the AFT unit can be dangerous. With inappropriate treatment, such an engine, which may transfer up to 2 kW to the propeller, can cause substantial damage. You now own a very efficient SLS that requires know-how, discipline, regular service and maintenance. Errors and lack in the assembly or with the operation of a model with a SLS can lead to property damages or body injuries.

Attention!

Before you take a model airplane in operation, you must find out about the legal regulations in your country. Legally, a model aircraft is an aircraft subject to relevant laws that must be observed at all times. Please notice rules like start-permissions or insurance obligations. In addition legal requirements that relate to the radio control system need to be considered. The regulations of the respective country must be observed accordingly.

Warning!

It is your responsibility to protect others from injuries. The minimum distance from residential areas to ensure the safety of people, animals and buildings must be at least 1,5 km. Keep distance from power supply lines. Do not fly the model in bad weather with low clouds or fog. Never fly against direct sunlight because you may lose the eye contact with the model. To avoid collisions with manned or unmanned aircraft, please land immediately when approached by such aircraft.

Warning!

Commissioning and operation of the Model and / or the engine under the influence of alcohol, drugs, medicines, etc. is absolutely forbidden. The operator must be in the best physical and mental condition and also well concentrated. This applies both to the operator and any assistants.

Warning!

The AFT unit was exclusively designed for ground take off of model airplanes under its own power. Other launching methods are not allowed to be undertaken with running motor for safety reasons.

Warning!

We particularly would like, once again, refer to the fact that the AFT unit and its motor controller require a certain cooling time, after a defined runtime. As default we specify the following values: For a ground test run, the switch on time shall not exceeded 60 sec.! In flight do not exceed 180 sec. continuous runtime. In addition each runtime must be followed by a cool down period of 5 min. for the motor and speed controller, as only little air is moving around within the fuselage. If the ambient temperature exceeds 27°C (80°F) the cooling phase must be extended. The temperature behavior of the motor can be read off from the 4 dots temperature sensor.

The fourth dot with 71°C shall never get black! If this happens, the motor was probably overheated and must be sent in for check-up to Schambeck Luftsporttechnik. It is advisable to provide good airflow within the fuselage, which can help to cool down the motor and controller! In addition it lies on the operator's responsibility to verify if a new battery pack does not exceed the permitted max voltage of the self launch unit. This is particularly important with new batteries, since voltage level is improved and increased by each new generation. All these recommendation shall also refer to the fact that an AFT unit is not a "PLUG & PLAY" device; with which there is no need to think about it. Since Schambeck Luftsporttechnik cannot control the operation, it is the sole responsibility of the end user to make sure that the system is used within its specification and not to overload it.

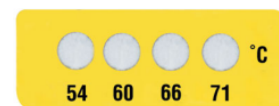

Attention!

People or animals must observe the following minimum safety distances from the aircraft engine:

- Before engine 5 m
- On the side of the engine 10 m
- Behind the engine 2 m

Warning!

This self launch unit was exclusively designed for model airplanes and is not suitable for any other purpose. In no case it shall be used for persons or goods or any other way of use, except exclusive for model airplanes, since any other intended use can lead to property damages or personal injuries.

Warning!

Note about the propeller:

This is a single blade propeller which is not comparable to a two blade propeller, it is extremely sensitive about balance. Any changes (even color markings) may not be made under any circumstances. This single blade propeller may only be used with the AFT. Occasionally, it is recommended to clean the blade with a damp cloth. Besides that the general safety rules for propellers are valid.

Warning!

Any deviation from the instructions in this manual, the use of other parts or materials and changes in construction, may impact adversely the functionality of the engine and must therefore be avoided under all circumstances.

Warning!

The operation of this SLS shall only be undertaken with exact observance of the guidelines in these instructions. Also to be considered are the general radio controls verifications and the CG of the airplane. All control surfaces need to be checked for proper operation/deflection, a full range check shall be made with collapsed antenna. The check shall be repeated with the SLS in operation and the model well attached to the ground. Besides that, refer to your radio control safety rules.

Warning recommendation!

- Be aware that the motor will start automatically once driven out from its housing.
- Never operate the motor in closed or restricted area.
- Never put cloths or pads inside the SLS or inside the fuselage, this can lead to faulty operation of the limit switches and unexpected start of the motor within the fuselage.
- When testing or programming the transmitter or motor controller, hook up a nearly empty battery, to avoid by any misshapen that motor runs under full power.
- For testing or launching never hold the airplane from the front or the side, as you are within the prohibited safety zone of the SLS.
- Connect the battery only just before takeoff, thus even with retracted SLS.
- Before every launch make a complete control check and an SLS check.
- Before switching off the receiver, the flight battery needs to be cut off (otherwise the propeller is oscillating inside the fuselage).

Attention!

Turn on the power train always at an altitude that in case of failure you can land the plane with ease.

Exclusion of liability and damage

Compliance with the installation and operating instructions in conjunction with the model and the engine, as well as the installation, operation, use and maintenance of associated components can not be monitored by Schambeck Luftsporttechnik. Therefore, Schambeck Luftsporttechnik assumes no responsibility for any loss, damage or costs arising from the erroneous operation, erratic behavior or anything connected with the foregoing. Unless otherwise prescribed by law, the responsibility of the company Schambeck Luftsporttechnik (resulting from the use of the model and the engine) to pay damages for any reason is excluded (including personal injury, death, damage to buildings, as well as damage caused by revenue or loss of business, interruption of business or other indirect or direct damages).

The total liability under any circumstances and in any case is limited to the amount that the buyer has actually paid for the airplane or the engine. Commissioning and operation of the model and the engine is done solely at the risk of the operator. The buyer agrees that Schambeck Luftsporttechnik is not able to monitor or control wheter this manual - regarding the installation, operation, use of aircraft, engine and use of the remote control – is followed appropriate. From Schambeck Luftsporttechnik neither promise, contract agreements, guarantees or other arrangements to any person or entity with respect to the functionality and commissioning of the model and the engine were made. At acquisition of the model or the engine, the customer has to rely on his own expertise and judgement and take on responsibility for it.

II. Terms of guarantee

The guarantee consists of free repair or replacement of any parts that have proven manufacturing or material defects during the warranty period from the date of purchase. Further claims are excluded. Transport, packaging and travel costs are at the expense of the buyer. We accept no liability for damage in transit. When returning to Schambeck Luftsporttechnik or to the approved service center for the country, a description of the fault and the invoice with the purchase date is needed. The warranty is void if failure of the component or model is caused by an accident, improper handling or incorrect usage.

III. Checklist

Check prior start:

- Rx battery fully charged?
- Main battery fully charged?
- Control surface check and SLS check with and without Battery hooked up (arm moves out, move propeller out of neutral position, retract arm).
- Radio range test!
- Check proper operation of prop brake on motor controller.
- Initialize timer for engine runtime control.

Check after landing:

- Disconnect main battery!
- Switch off Receiver!
- Check the whole SLS for any damage.

IV. Installation instruction

A. Determine the SLS hole position

The relevant sketches for installation instruction can be found at the last pages of this manual.

1. Tape the top of the fuselage with some transparent packing tape.
2. Determine the front edge position of the SLS opening and mark it with a water resistant thin foil pen. That dimension is attached or you get it directly from Florian Schambeck Luftsporttechnik.

Attention: Front edge SLS hole is not same as the wooden frame front edge (see [Sketch 1](#)).

3. Now trace the front edge of the SLS hole. That can be done easily by securing a steel ruler with some tape against the fuselage as you can see in [Image 1](#). Mark the center of the opening. The width of the opening is 75 mm.

Caution: The fuselage molding line is not always in the center!

To set the width you can also use a caliper, set to 75 mm, or use the wooden frame as gauge. The small notches in front and the back of the frame indicate the center.

4. Next you mark the center line of the hole. It must be 215 mm long. Afterwards you can draw the rear edge of the hole, exactly the same way you did with the front edge.
5. Position now the wooden frame centered as seen in [Image 2](#). The crossbrace of the wooden frame has to be positioned 1-2 mm in front of the leading edge of the hole. For this, look at [Sketch 1](#) and [Image 3](#). The frame serves as guide for the lateral edges. If needed the frame may be reworked so it better fits fuselage curvature. Make sure that the wooden frame sides are really straight, if necessary correct. Attach the frame with tape. Mark the lateral edges with the pen now. Remove the frame and check your drawn lines with the caliper or the steel ruler. Inside width must be 75 mm exactly.



Image 1



Image 2

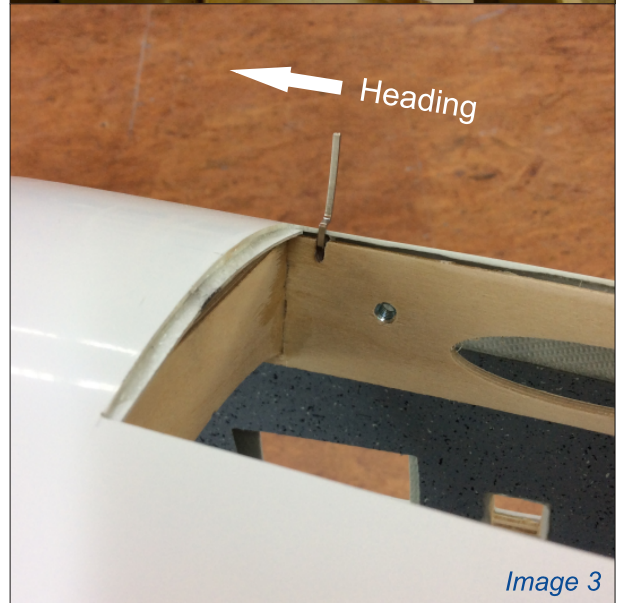

Image 3

B. Cutting out the doors with a knife

Alternatively, you can perform this step with a saw (view C.).

1. There is a possibility to cutout the doors with round corners. This choice does not affect the way it will be cutout. The recommended and simple way to cut out is by using a sharp cutter. Alternatively you can use miter saw with a thin blade. This is described in a separate chapter. We recommend the method with the cutter, since it is the simplest one and most precise one. To make those round corners, use a large washer, with an inside dia of around 12 mm, which you can use as a marking guide and later as cutting guide. See [Image 4](#). The round corners are however only for visual effect. You can make square corners exactly the same way.

2. The cutting out of the door works as follow: Identify first the doors arrangement (left, right, front, back). Best to start cutting the centerline. Put the steel ruler along the center line and fix it firmly with tape. The ruler serves as guide for the knife. Turn the knife upside down as shown in [Image 5](#), to have the back of the knife lay against the fuselage. Scrape with the knife back edge along the ruler, as many times as needed to cut through.

Attention: The sharp side of the knife is up and you need to protect yourselves from the sharp edge!

Don't exert too much pressure when cutting. It is recommended not to cut the whole length of a cut at once. Begin always from an edge and cut to the middle, then start from the opposite side to the middle again. It will prevent cutting outside the edge line. As next you can cut the sides up to the round corners.

Attention: The side edges of the holes are not necessarily straight.

You may scrape the cut by section, do not try to cut without a ruler by free hand. Afterwards cut the front and rear edge away. Here the steel ruler fixed with tape is very good as guide.

3. If you decided to cut round corners, stick the washer firmly with tape to the corners, and scrape with the back of your knife. The result should look as shown in [Image 6](#).
4. Remove the doors from the fuselage and with fine sandpaper carefully sand the edges, don't sand too much to keep the gap small!

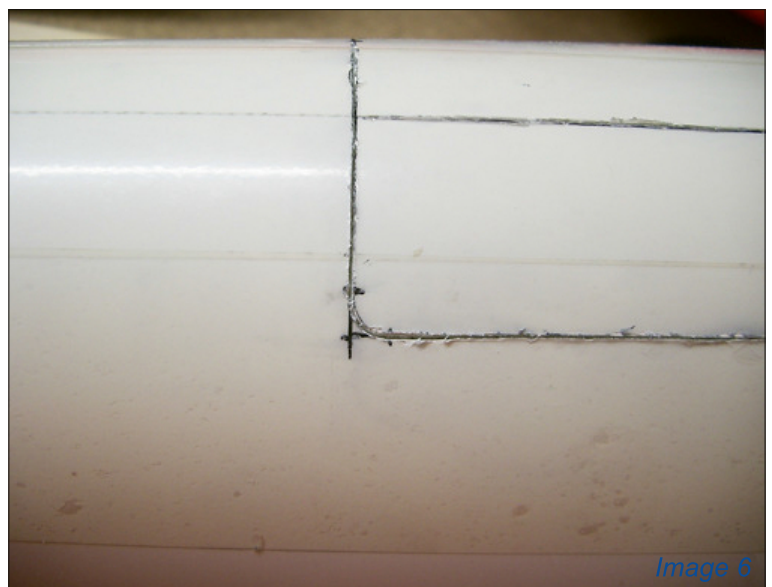
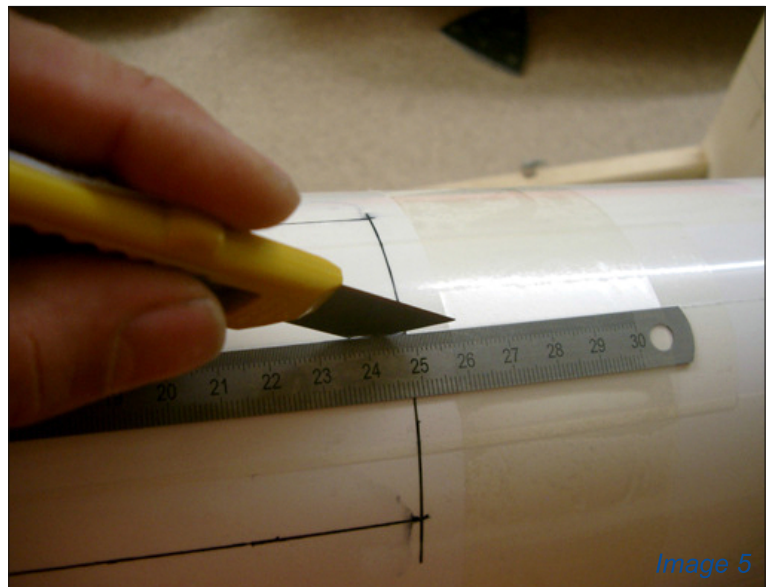

C. Cutting out the doors with a saw

Optionally, you can separate out the doors with a saw.

1. Mark the doors (right, left, back, front) as above.
2. With a small drill (0.6 mm in diameter) drill a row of holes so that a fine saw blade can slide in.
Attention: To keep the correct size of the doors, the cut must be made outside of the line given by the wooden frame.
3. In order to prevent door flutter, these shall be fixed with tape.

D. Installation Angle

Since every fuselage has a different outline, the rear screw holes must be drilled on site.

1. Drive the SLS out and disconnect it.
2. Unscrew the wooden frame and slide it into the fuselage.
Caution: Without its wooden frame the SLS arm can fall out of its housing.
3. The wooden frame has a slight camber on top, it must, if necessary, be adapted to the fuselage outline.
4. Slight the SLS assembly through the cutout hole into its frame. Or better slide the whole assembly from the front into place.
5. Tape the wooden frames against the upper inside of the fuselage. This is an ideal method for fixing framework in place during fitting. It will allow as well, the arm to move in and out.
6. Now fit the front screws in assembly to secure the unit to the frame.
7. Now position the motor arm assembly, making sure you have the correct angle (see [Sketch 3](#)) and then with a sharp pencil trace the upper edge of the arm housing against the wooden frame (see [Image 7](#)). Once you have marked the correct angle with the pencil it can be lined up easily again after removal of housing.
8. Now you can remove the complete SLS from the fuselage, including the wooden frame.
9. Screw the arm again into its frame with the front screws and hold the back with small fastening clamps, aligning the housing in its frame along the marked line.
10. Using the rear holes in the wooden frame as guide, drill a 4 mm hole through into the housing.
11. Then drill out the two 4 mm holes, in the wooden frame with a 5 mm drill, and fit the blind nuts.



E. Installation of the wooden frame

Now the fuselage is prepared for installation. Take enough time in the averaging that everything is true!

1. Sand the area inside of the fuselage where bonding will be..
2. To bond the frame in place we recommend to install the fuselage upside down, for example by using a chair or even by hanging it from the roof.
3. Make sure that the extended arm is aligned with the fin.
4. Make sure that the notches from the wooden frame align with the front edge (see [Sketch 1](#))!

5. Attach first the frame alone with some tape to the fuselage, like how you did it when determining the angle.

Attention: If you have the installation set accessories for fastening the doors, you must now fix the bowden tube with some CA into the groove. Block tubes end to avoid later the resin to penetrate during the bonding procedure.

Take care to apply the tape firmly against the fuselage to avoid the resin running underneath that tape. To bond the assembly in place the arm assembly must be screwed onto its wooden frame and the arm must be driven out. The tape shall not be removed as it will result in the necessary gap to the arm to move freely within the frame. If the frame is too tight, the arm will jam in the upper part.

6. Front and rear of cutout can be strengthened with fiberglass (e.g. 6 oz/ft²) and resin.

7. Wet out the bonding area with thin epoxy, place the wooden frame to its exact position. Then use thickened epoxy (chopped fiberglass and micro balloon). If you don't feel safe, you may just as a first step, secure the frame with some resin (approx. 5 g) to hold it in place. The next day you may drive test the assembly and if satisfied you can finish the bonding (with approx. 20 g).

Attention: Make sure to sand again well the bonding surface!

V. Doors assembly

Hinging the doors with the installation set by Schambeck Luftsporttechnik.

1. First you will need to slice the bowden tubes at the four hinge location.

2. Now you can insert the supplied hinges and the steel wire in place, the frame must be slightly reworked on those places to give the hinges free movement.

3. Now remove the SLS assembly from its frame.

4. Now place the doors in their proper arrangement and tape them down. Make sure to have an equal gap around the doors.

5. Turn the fuselage again upside down on its back and bond the hinges against the doors from the inside. Make sure that the long part of the hinge nicely mates the door shape. If necessary bend accordingly. We recommend tacking first the hinges in place with some CA, now you can verify the functionality. If all is fine, remove the hinges and finalize the bonding of the hinges against the doors with thickened epoxy.

6. Now you can cut out deflector guides and glue them accurately on the doors as shown in [Sketch 5](#). Pay attention to the installation direction so that the large roundness is in the center.

7. You can also bond the two rubber bands as shown in [Sketch 5](#) and [Image 8](#) against the doors.

8. Please check the doors operation and adjust as required for smooth operation! If the doors are stiff or jam, the SLS might not be able to drive in and out safely and cause problems.

9. In [Image 9](#) you can see the ready installed doors with solar cell stickers on top. The stickers can be ordered optionally. Before gluing the stickers, the doors need to be thoroughly cleaned.

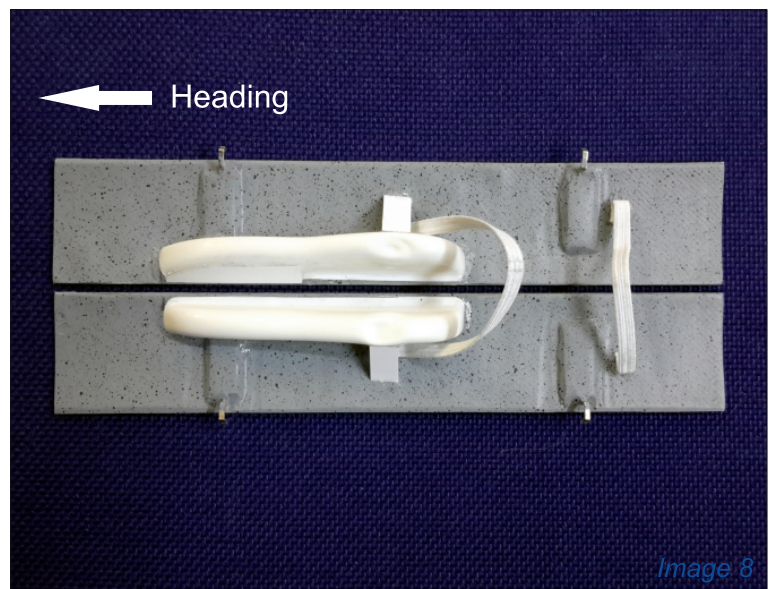

Image 8

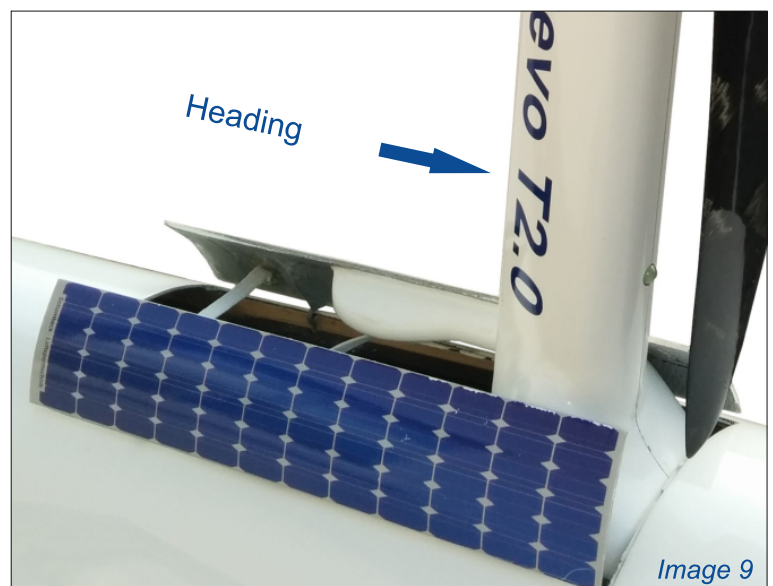

Image 9

VI. Electrical wiring schematic

Please also refer to [Sketch 4](#).

- The current supply for the SLS control is taken from the receiver battery. The receiver battery must as usual in large scale models, have sufficient Capacity, the SLS control unit supply voltage is between 5 and 7,5 Volts, so if using a 2s lipo a voltage regulator will be required for the correct voltage.
- The SLS units needs about 5 mAh to drive once in and out, while the max current may reach up to 1.5 A. The stall current is about 2.5 A.
- In rest condition it only will draw 28 mAh.
- The main drive battery shall not exceed the maximum voltage indicated on the AFT identification plate.
- A shielded cable tree extension from the motor cable to the controller is offered (made to measure).
- The wooden cable chain fixation needs to be installed as follows:
With retracted SLS, the last chain link which is screwed on the wood strip, which must be clicked to the end of the cable chain. Afterwards you drag the strip gently forward until the chain is slightly tensioned. From this position you slide the strip ~3 cm to the back (the chain should be not tensioned now). Now the little wooden part must be glued with 5-min-epoxy to that position. In [Image 10](#) you can see the ready installed strip with cable chain.



VII. Propeller adjusting

Please link the ESC and the motor as color-coded.

Attention: When you first switch on the power, pay attention to the rotating direction!

If the rotating direction is wrong swap two of the three connecting cables from the motor. If the zero position of the propeller isn't correct, it's possible to readjust the position. On the left side of the SLS, near the motor, you will find a hole with a round sticker, with 2.5mm allen-key this can then be adjusted to the correct position. If you turn the screw clockwise, the zero position shifts to the left viewed from the front (and vice versa).

Attention: Please be extremely careful during fine tuning since the electronics are very fragile and can be easily destroyed. Please disconnect the flight battery before.

The screw must not be turned too far either way, so please check always which way to turn before adjusting. Normally readjustment is not necessary. A slight deviation is normal and technically not easy to prevent, though the propeller blade tip should always be within the area of the arm body. Please make several reset tests, since the position is not always exactly the same. On average, the position should be as seen in [Image 11](#).

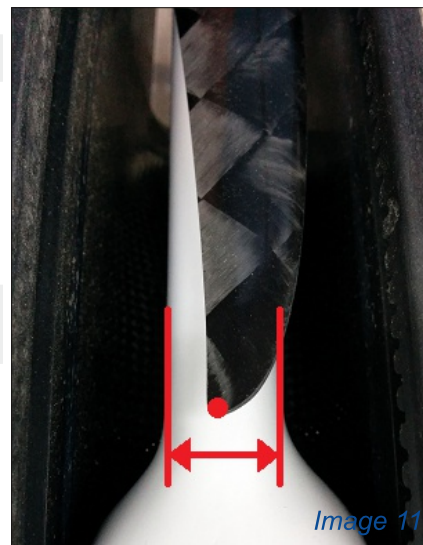

VIII. Operation description

Attention: The following description is written for Graupner/ Weatronic transmitting systems. In case you use another system, the servo travel or the zero position can be changed.

The following table shows the servo travels of other systems, please replace the values in the description by the values of your system.

Millisec.	1,1	1,5	1,9
Graup./ Wea.	-100%	0%	+100%
Futaba	-70%	-3%	+63%
Multiplex	-90%	-18%	+54%
Multiplex uni	-72%	0%	+72%
Jeti	-80%	0%	+80%

Please also refer to the [video "Schambeck AFTevo Funktionsbeschreibung"](#) on our Youtube-Channel!

There are 3 different ways to operate the engine:

A. 2 Position switch

- Travel is switchable between -100% (engine retracted) and +100% (engine extended and full throttle).
- After plugging in the flight battery, the engine must be reinitialized. For this you have to switch to +100% once until the engine is completely extended and the motor stops beeping. After that the engine must be retracted (switch-pos. -100%), to complete the initialization. The next time you extend the engine completely until it reaches the limit switch, the motor starts running.

B. 3 Position switch

- Travel is switchable between -100% (engine retracted), 0% (engine extended and initialized) and +100% (full throttle).

- After plugging in the flight battery, the engine must be switched from -100% to 0% (switch in central position). In this switch position the engine extends and the initialization process begins. When initializing is finished, the motor stops beeping and the engine can be switched to full throttle (switch-pos. +100%). In case you would like to have the motor starting slowly, you can program a delay with your transmitter exactly the same way as you do to slow a servo.

C. Infinitely variable power/ with throttle stick/ with slider

- Travel is switchable (with a 2 Position switch) between -100% (engine retracted) and 0% (engine extended and initialized). The engine power from 0% to +100% is infinitely variable by using the throttle stick or any slider on your transmitter.
- After plugging in the flight battery, the engine must be switched from -100% to 0% (switch in end position). In this switch position the engine extends and the initialization process begins. When initializing is finished, the motor stops beeping and the engine can continuous be regulatet with throttle stick or slider.

Attention: Since the spoilers from most gliders are controlles with the throttle stick, a special programming must set up for dual control.

- For this purpose, with changing the switch to extend the engine, the flight phase must be changed. In flight phase 1 (switch at -100%, engine retracted) the throttle stick operates as spoiler control with neutral position in front. In flight phase 2 (switch at 0%, engine extended) the throttle stick operates as power regulation for the engine with neutral position in back. Therefore, during the engine extension, the throttle stick must be moved from front position to back position (idle position). Once the engine is completely extracted, you can apply throttle.

You can choose which of the 3 options work best for you. Programming should always be done very thorough and in relaxed atmosphere to avoid mistakes.

Follow the operating instructions of your radio control system and read them thoroughly before starting programming.

D. Engine testing with and without flight pack

- When the engine is extended with the flight battery connected (switch-pos. 0%) and hits the limit switch, but the motor is not switched on, the propeller determines the neutral position prior the retracting (switch-pos. -100%) by itself. This can be seen by the fact that the propeller wobbles around the neutral position or turns one complete turn until stopping at neutral position. Subsequently the engine retracts.
- If power battery is NOT connected, it is important to distinguish between two situations: If the engine only is extended but no throttle is applied (switch-pos. 0%), it can easily be retracted without any further activity. If the arm is extended, and throttle is applied (travel >0%), the following needs to be observed: Within the first 4 seconds after hitting the completely extended position the engine can be retracted without further ado. If the engine remains extended more than 4 seconds, the receiver has to be unpowered. With the switch at retracted position (switch-pos. -100%), the receiver now is powered on again and the engine retracts.

IX. Remote control and SLS control

A. Electronics installation

Electronic components shall be installed with the same care as a receiver. Install the SLS sequencing unit with double-sided foam tape or with Velcro tape at least 10 cm away from the receiver. The ribbon cable must not be under tension.

B. Programming the SLS controller

The SLS controller must be programmed only when an individual adjustment of the preset idle up function is required. The SLS controller stores all adjusted values in its internal memory. The values are stored not immediately during the adjustment, but only once the end of the programming sequence is reached. If you should have made an error, you can switch the sequencing unit simply off and start again programming. Adjustments are made with a programming adapter. This is connected onto the sequencing unit into a little black socket opposite the lead. The plug is pole-protected by a missing pin. The signal values for the motor control output, to which the ESC is connected, are factory set. They correspond to -100% travel on a typical JR transmitter for motor OFF and +100% for motor ON.

Attention: Prior every start the motor brake and the propeller position need to be checked.

If you want to reset all values back top factory settings (80%), follow the Reset instructions (see E.).

C. Limit switch verification

Special attention must also been taken on the small limit switch stop. When the AFT is driven out the limit switch must always remain closed (even in air drag). If this is not the case it can lead to a serious malfunctioning of the AFT. The correct operation of the switch is checked as follows:

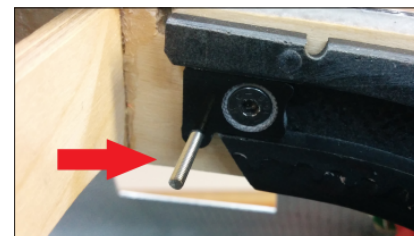

Extend the SLS (without power battery plugged in). In the last 1 /3 of extension, apply some resistance against the arm with your hand, to simulate the wind drag, but let the AFT drive fully up to the end. The switch must be pressed and remain pressed. The arm can be moved in all directions to make sure that the switch remains closed. By sliding a thin silicon tube over the wire, the actuation point of the switch can be modified.

D. Programming the idle up function

The "idle up function" describes a kind of soft start for engines. This helps by making the rolling start of your glider more controlled, when set up correctly the engine does not instantly switch from 0% to 100% power, causing tipping of the nose on the taxi run, this is prevented by setting the program to ramp up to 80% power and continuing up to 100% after a short amount of time. You are able to set the percentage in programming mode.

To regulate the idle up function, the programming adaptor needs to be connected to the SLS controller. The SLS controller is linked with the dedicated channel on the receiver. To activate the programming mode, you have to push the "selection" button on the programming adaptor while switching on the receiver (transmitter on first as always).

Meanwhile the green LED at the SLS controller glows. After the power is switched on, you may release the button where you will get two long beeps (shown as " ° ") confirms that the programming mode now is activated..

° ° ⇨ Programming mode

With the "selection" key you can now select the desired servo. After pushing 4 times (and 4 beeps as confirmation), you get to the position "take-off performance". According to the servo number the green LED also flashes.

±	empty
±±	empty
±±±	empty
±±±±	take-off performance
±±±±±	empty
±±±±±±	empty

Here you can adjust with minus and plus keys, the motor power level during the first 2 seconds of the start. The standard adjustment is 80%. This can be changed in 5% steps (single beep) between 60% and 100%. With Simultaneous pressing of the "plus" and "minus" key the value is reset to 80%. The following graphic illustrates the delay and all possibilities to adjust it.

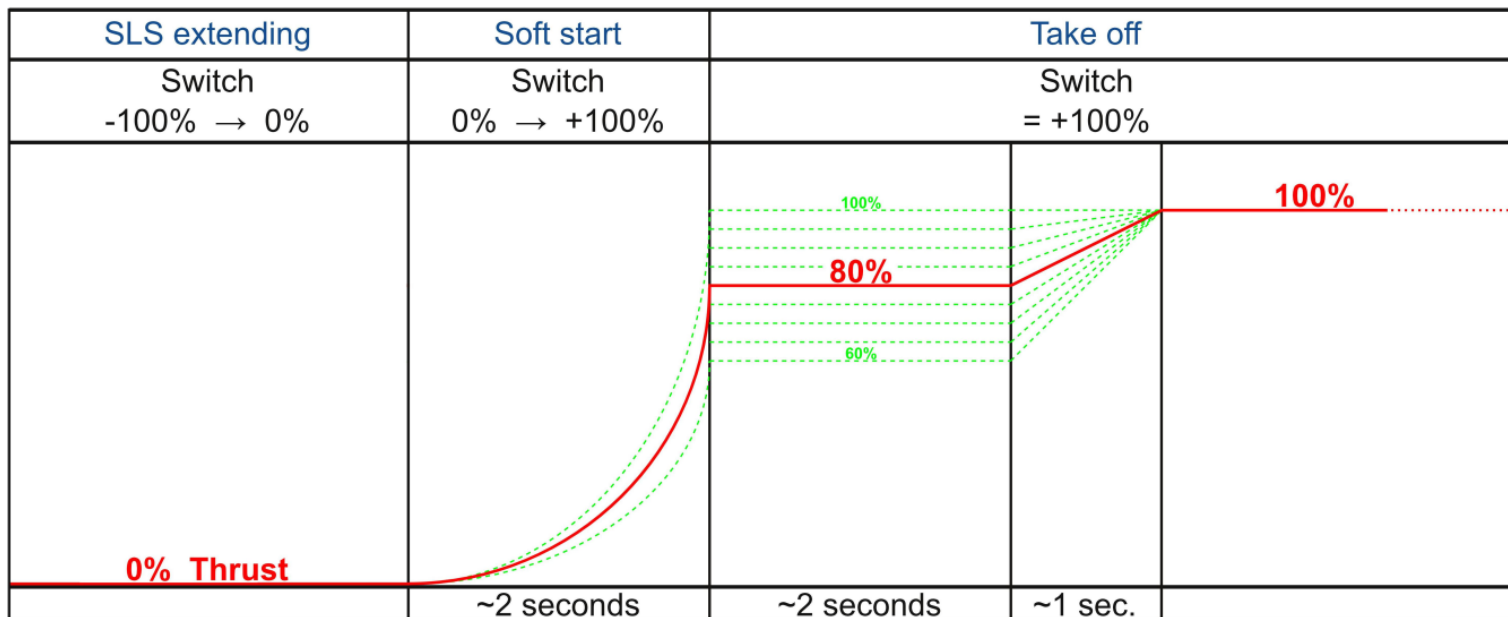

You will only need this adjustment during the first launch attempts with your model. You can of course familiarize yourself during the installation phase of SLS.

It is advisable though to replace the controller with a regular servo (at exit "Motor") to see the behavior. Adjust the startup power level such a way that the model begins to roll straight without tipping on the nose. After 2 seconds, throttle will automatically and slowly increase to full power.

This sequence works only once, after the control has been switched on and reached the 100% during take-off, the throttle will go full power directly if used again in flight. It completes the cycle the first time full power is achieved after switching on the sequencing unit, you can briefly test the unit by switching it on and off, as long as you interrupt the sequence before full power is achieved, you will still have the normal first start-up procedure.

Now to store those values you need to scroll through the selection with the selection key till you reach the end. When you reach the arm selection again, only then the values will be stored permanently.

E. Default values (Reset)

You can set all values back to factory setting (default), by pressing the selection button during 10 sec and power on of the sequencing unit. Five long beeps will confirm the reset.

◦ ◦ ◦ ◦ ◦ ➡ Reset, all values have been set back to default

X. Motor controller

The new AFTevo generation works exclusively with the YGE120HVT motor controller, which is fully programmed by us and should not be changed. Please refer to the accompanying operating instruction. Always allow adequate cooling for the controller. First of all check the rotating direction of the propeller, but let the engine by no means turn up!

Does the motor rotate the wrong direction with high revolution, the engine could be destroyed .

The rotating direction can easily be changed by swapping two of the three connecting cables from the motor (see [VII. Propeller adjusting](#)).

Attention: Our SLSs aren't designed for partial load operation (see [I. Warnings and safety instructions](#))!

XI. Maintenance

- The guides in the housing shall be never greased or oiled.
- After long period of operation or once a year, if necessary, clean the guides and teeth in the housing with brush and cloth.
- The large white gear from servo (at the lower end of the SLS arm) can be lubricated, if the AFT drive has difficulty to drive out, with some teflon- or silicone oil.
- The propeller should regularly be cleaned from dirt with a damp cloth (see however the warning reference „Note about the propeller“).
- After the first 20 starts the self launch unit shall be sent in to Schambeck Luftsporttechnik or its authorized partners for check up and readjustment.
- The maximum lifetime of an AFT is six years.
- Prescribed maintenance interval is one year.

XII. Technical data

All our SLSs are innately designed vor 10s Lipos. If favored, other configurations are possible.

AFT19evo	weight	input power	flight weight	typical gliders
T 1.2	~1300 g	~1000 W	up to ~12 kg	ASW 15 1:3
T 1.5	~1300 g	~1200 W	up to ~15 kg	Ventus 1:3 / ASH 26 1:3
T 1.8	~1350 g	~1400 W	up to ~18 kg	Ventus 1:3 / Quintus 1:3 / ASH 26 1:3
T 2.0	~1350 g	~1600 W	up to ~20 kg	Duo Discus 1:3,3 / ASH 26 1:3 / JS1 1:3 / ASH 31 1:3
T 2.5	~1350 g	~1800 W	up to ~25 kg	ASW 15 1:2,5 / EB 28 1:2,9
AFT25evo				
T 1.5	~1690 g	~1300 W	up to ~15 kg	lightweight two-seater 1:3
T 2.0	~1720 g	~1600 W	up to ~20 kg	Arcus 1:3 / Ventus 1:2,5
T 2.5	~1840 g	~1800 W	up to ~25 kg	Arcus 1:3 / ASG 29 1:2 / ASH 31/ASG 32/ASH 25 1:2,5
T 3.5	~1840 g	~2000 W	up to ~35 kg	DG-1000 1:2,2 / Arcus 1:2,5 / ASW 28 1:2

The CNC-milled wooden frames weigh 60 g (AFT19evo) respectively 70 g (AFT25evo).

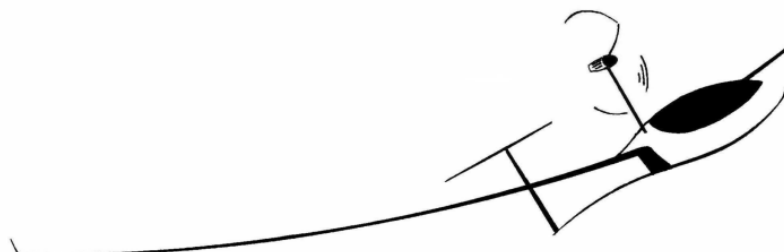

XIII. Attachment: Sketches

A. SKETCH 1

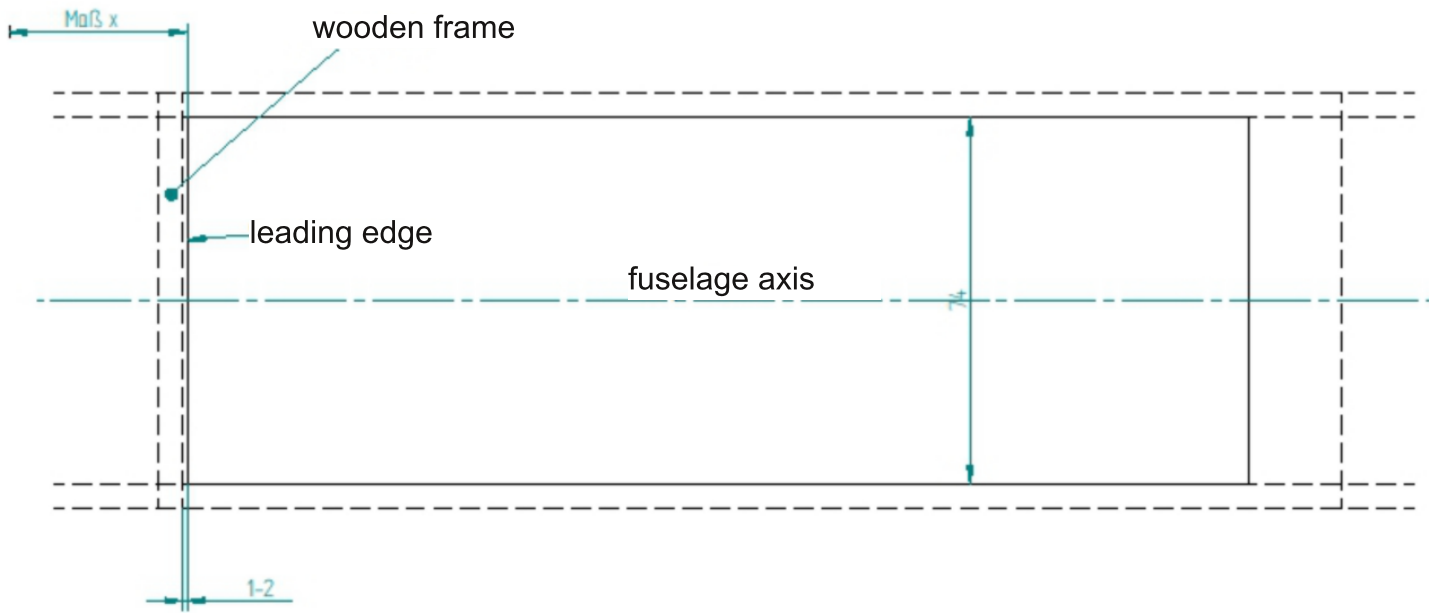

B. SKETCH 2

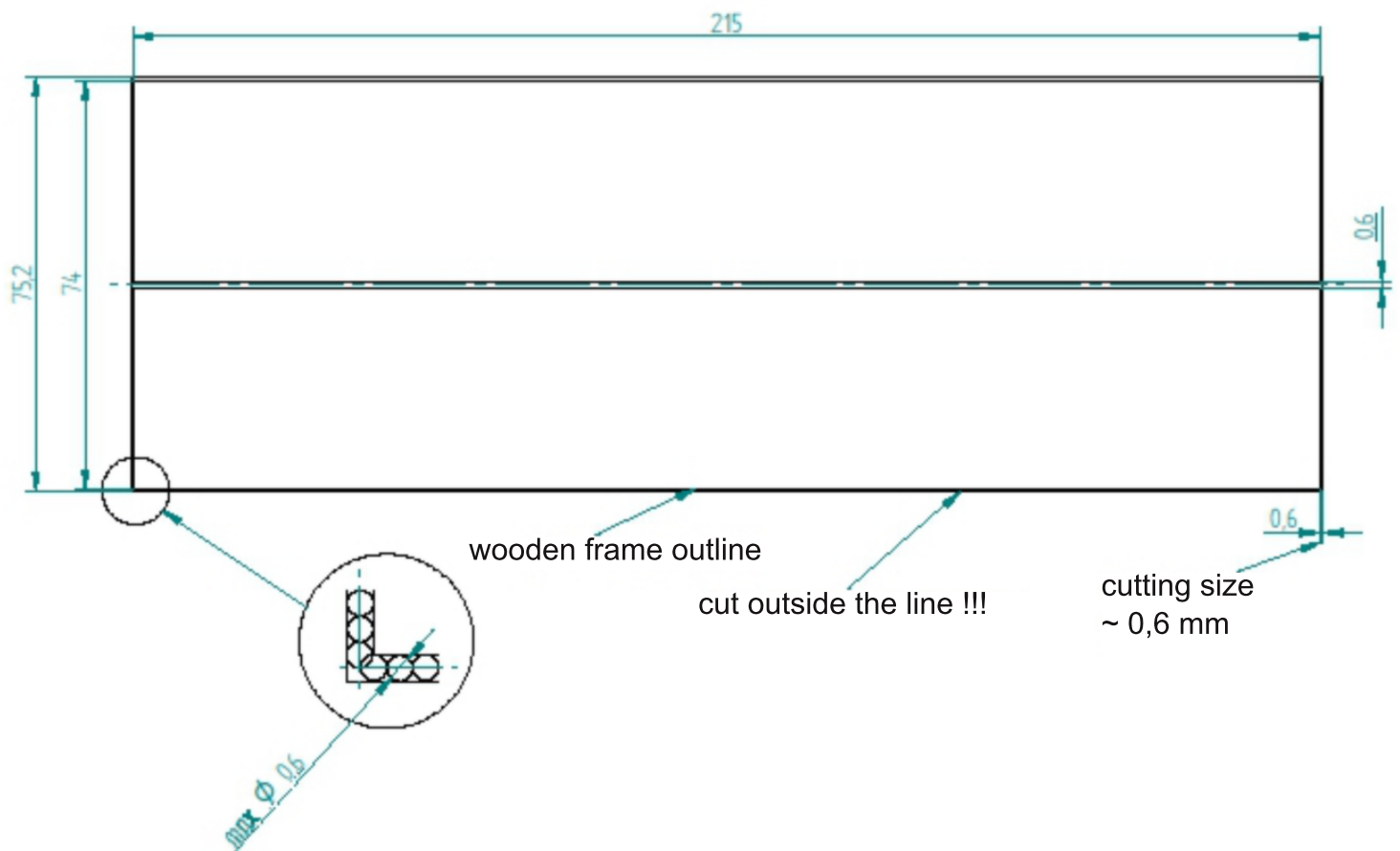

C. SKETCH 3

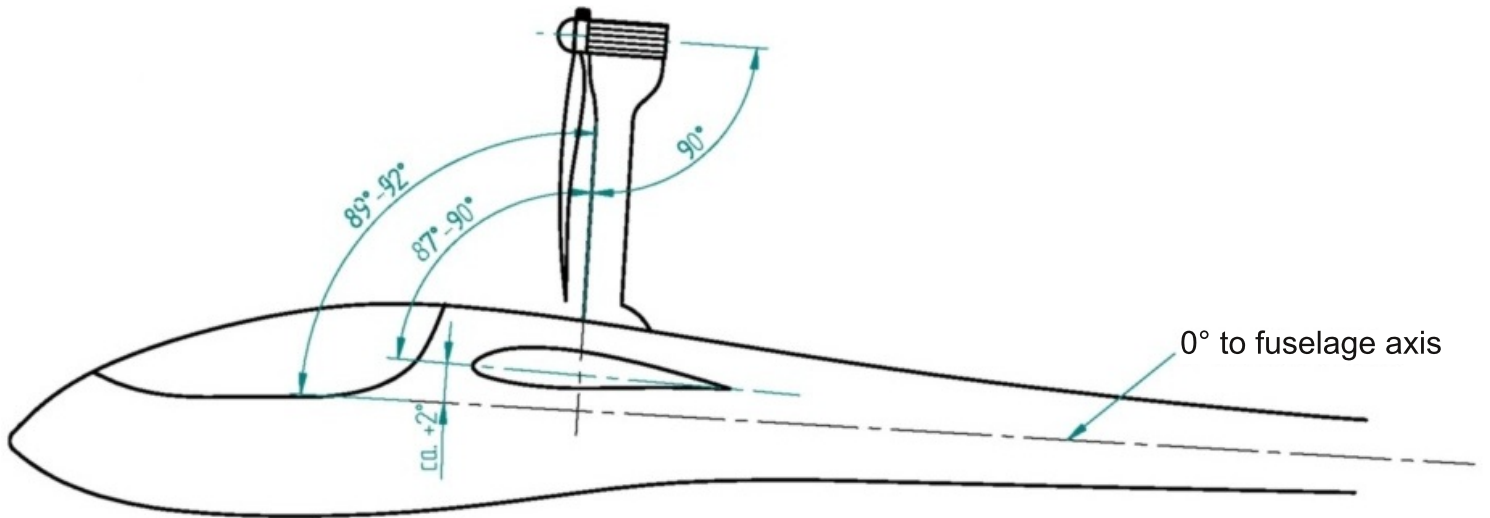

D. SKETCH 4

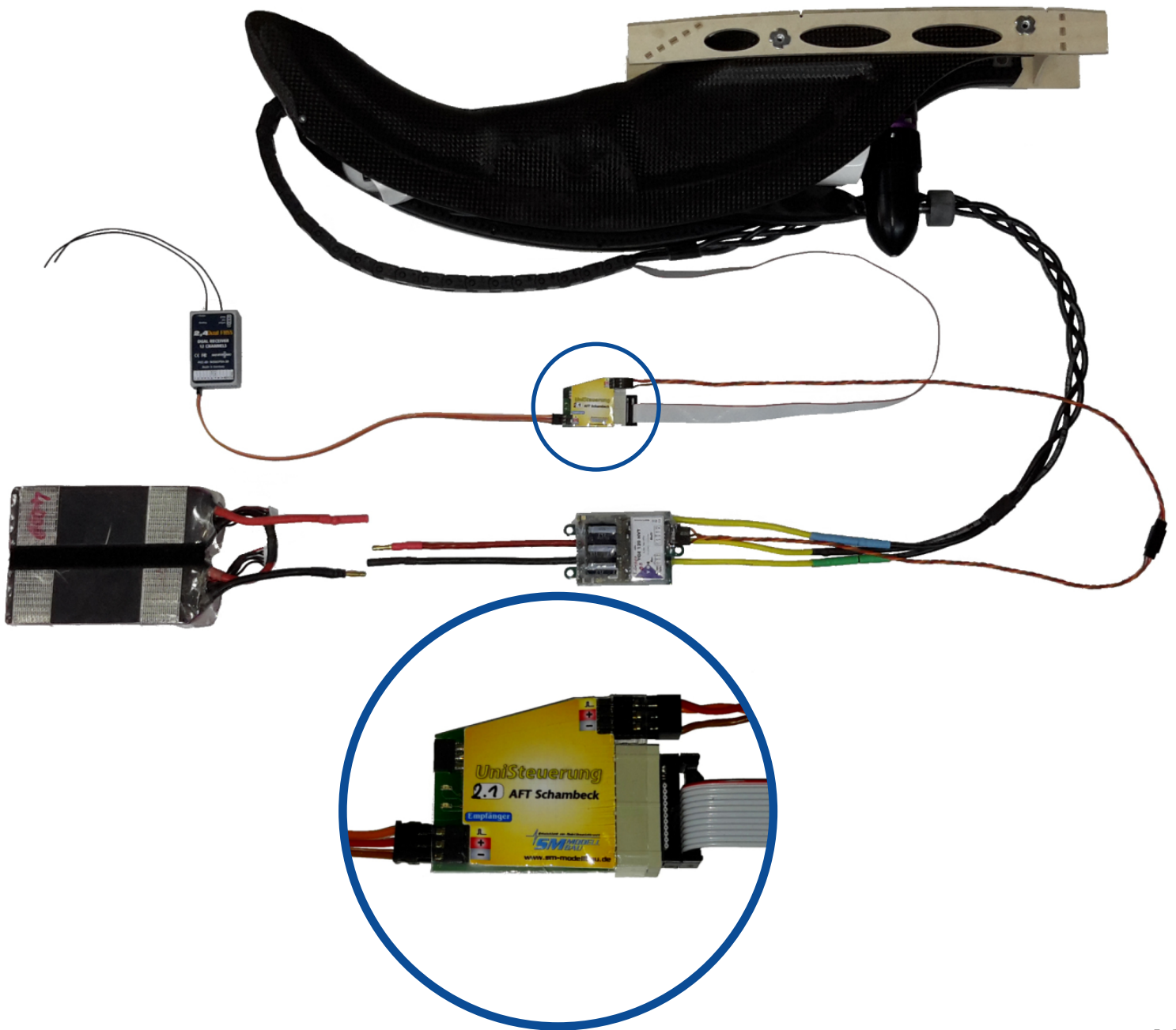

E. SKETCH 5

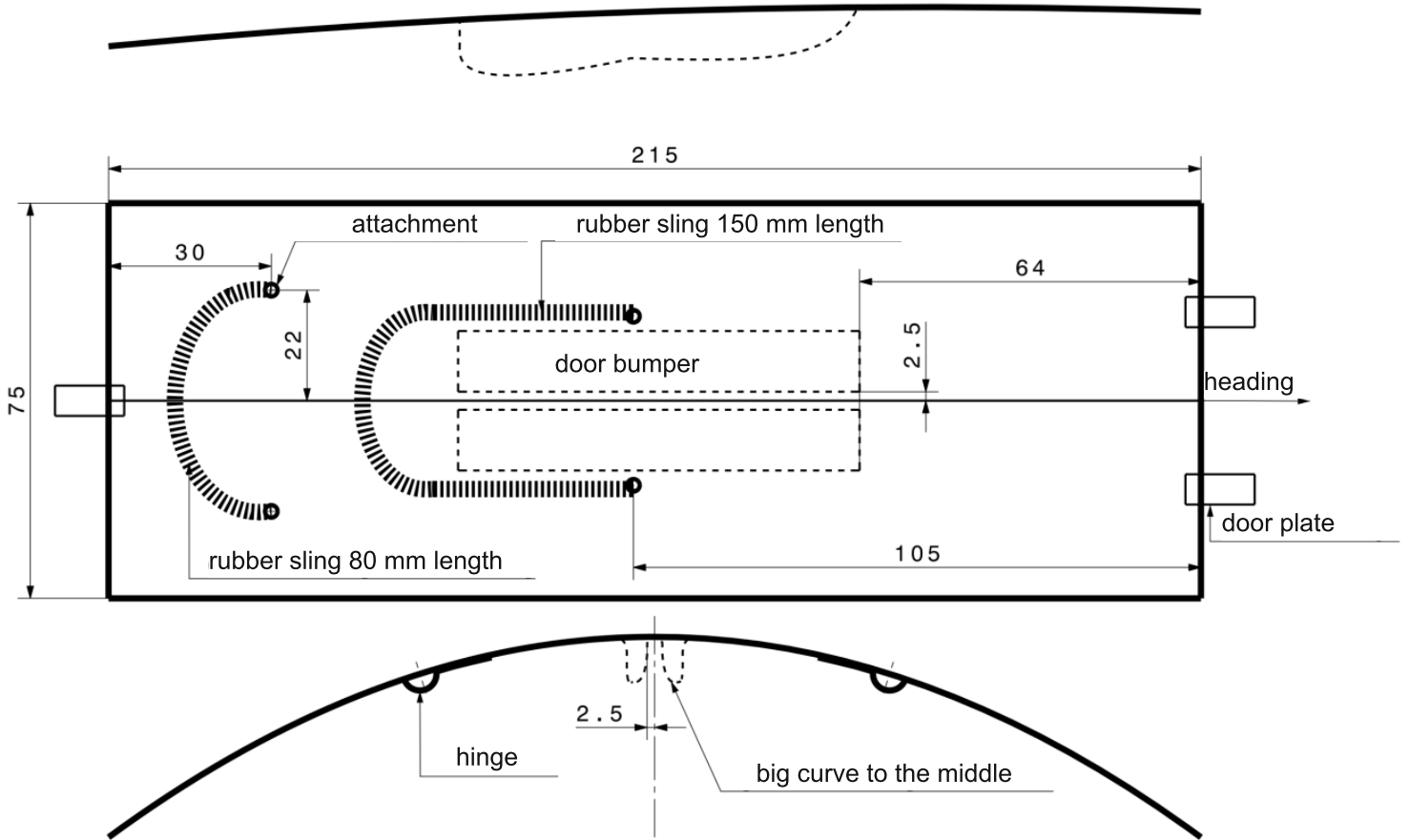

F. SKETCH 6

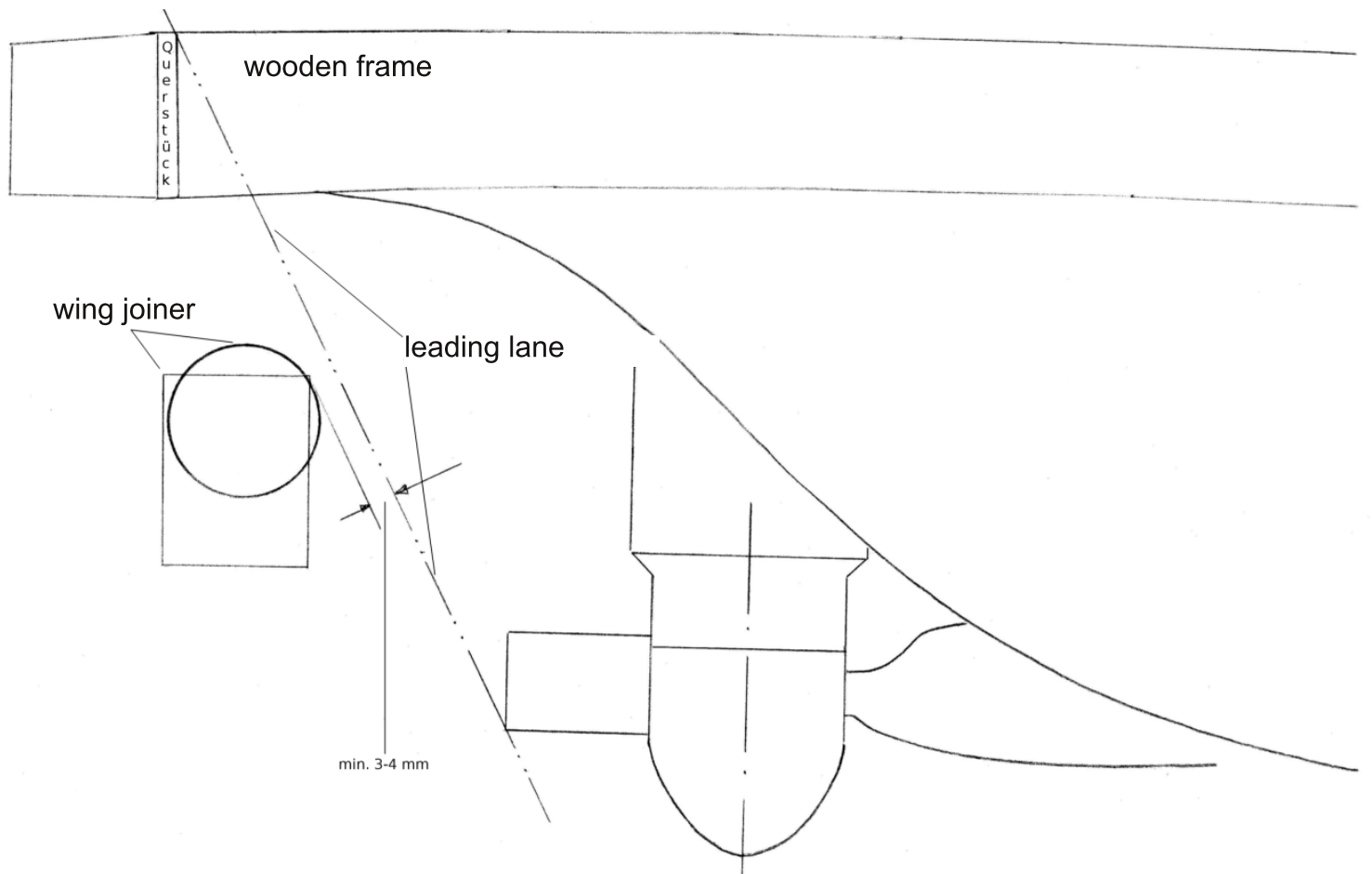

G. SKETCH 7

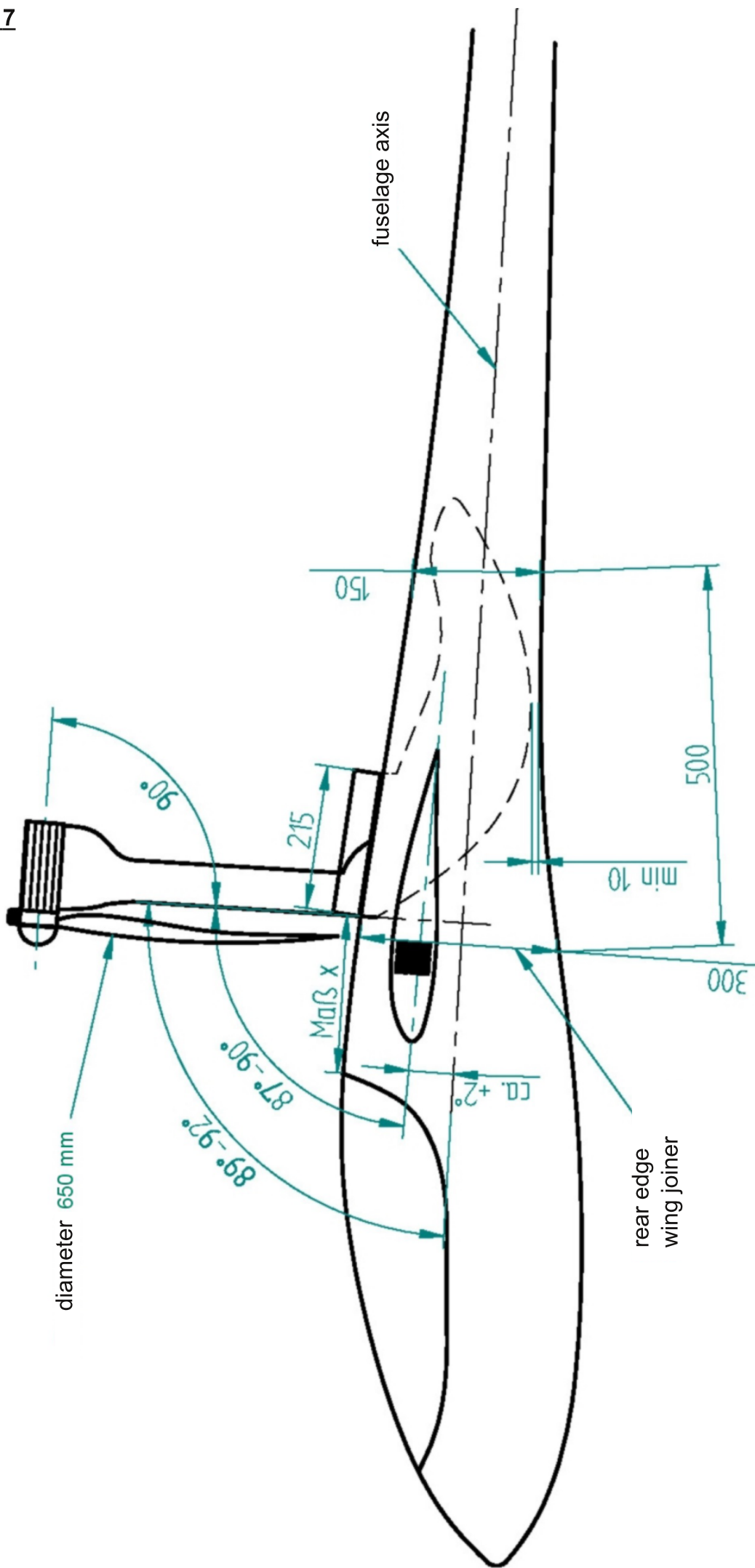

XIV. Flight logbook

To get an overview of the hours in operation, we recommend to perform a flight book!

Start-Nr	Date	Bat-Nr	Note/Service
1			
2			
3			
4			
5			
6			
7			
8			
9			
10			
11			
12			
13			
14			
15			
16			
17			
18			
19			
20			
21			
22			
23			
24			
25			
26			
27			
28			
29			
30			
31			
32			
33			
34			
35			
36			
37			
38			
39			
40			
41			
42			
43			
44			
45			
46			
47			
48			
49			
50			

Start-Nr	Date	Bat-Nr	Note/Service
51			
52			
53			
54			
55			
56			
57			
58			
59			
60			
61			
62			
63			
64			
65			
66			
67			
68			
69			
70			
71			
72			
73			
74			
75			
76			
77			
78			
79			
80			
81			
82			
83			
84			
85			
86			
87			
88			
89			
90			
91			
92			
93			
94			
95			
96			
97			
98			
99			
100			

